

TANK CAPACITY GALS.
1100/500

NOTES:

1. WEIGHT= 13800 LBS.
2. CONCRETE: 5000 PSI AFTER 28 DAYS
3. REINFORCING: 6X6 10/10 W.W.M. & REBAR
4. KEYED JOINT SEALED WITH BUTYL RUBBER
5. OUTLET FILTER INCLUDED WITH ALL TANKS
6. INLET PLASTIC BAFFLE AVAILABLE FOR NEW HAMPSHIRE

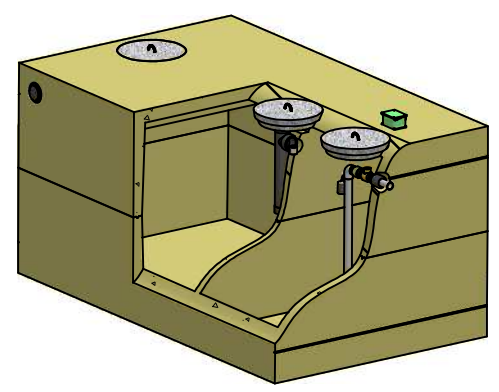

1600 GALLON 2 COMPARTMENT SEPTIC - PUMP TANK
238 Country Club Road (Route 4) Sanford, ME 04073
(207) 324-7215 (800) 477-8177
 Date: 4/9/2012