

TANK CAPACITY GALS.
1500/500

NOTES:

1. WEIGHT = 17600 LBS.
2. CONCRETE: 5000 PSI AFTER 28 DAYS
3. REINFORCING: 6X6 10/10 W.W.M. & REBAR
4. KEYED JOINT SEALED WITH BUTYL RUBBER
5. OUTLET FILTER INCLUDED WITH ALL TANKS
6. INLET PLASTIC BAFFLE AVAILABLE FOR NEW HAMPSHIRE
7. HD SEPTIC TANK TOPS ARE 6" THICK REINFORCED WITH 5/8" REBAR

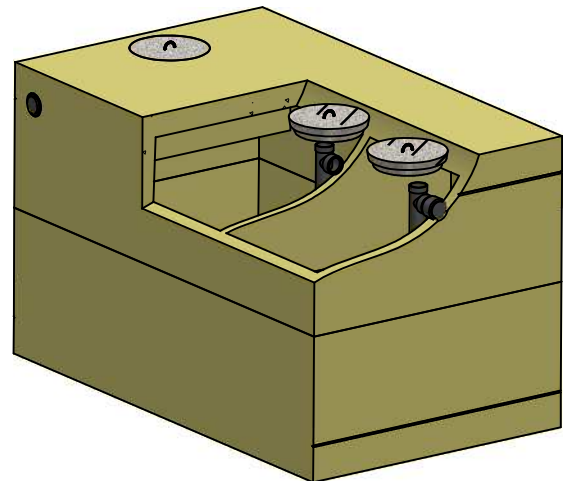

2000 GALLON 2 COMPARTMENT HD SEPTIC TANK
238 Country Club Road (Route 4) Sanford, ME 04073
(207) 324-7215 (800) 477-8177
 Date: 4/4/2012